

THERMAFLO

ENGINEERING COMPANY

Pneumatic Temperature & Pump Control Panel

Model: EC-800-PN-PM6

ELECTRICAL SCHEMATICS

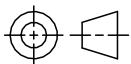
 DO NOT SCALE DRAWING	THERMAFLO ENGINEERING COMPANY <small>MANUFACTURERS of STEAM FIRED SPECIALTY EQUIPMENT</small>		<small>Since 1986</small>	<small>CHK'D BY</small> AS	<small>TITLE</small> ThermaFlo Engineering Co.		
	<small>DRAWING TYPE</small> Electrical Schematics		<small>DATE ISSUED</small> 04/13/10	<small>SCALE</small> N.T.S.	<small>DRAWING NUMBER</small> S03233-1	<small>REV</small> 0	<small>SHEET</small> 1
<small>COPYRIGHT ©2004 SOLVERE LLC, BELMONT, NC, USA. ALL RIGHTS RESERVED. DESIGNS ARE OF A PROPRIETARY NATURE AND SHALL NOT BE REPRODUCED.</small>							

SYMBOLS LEGEND:

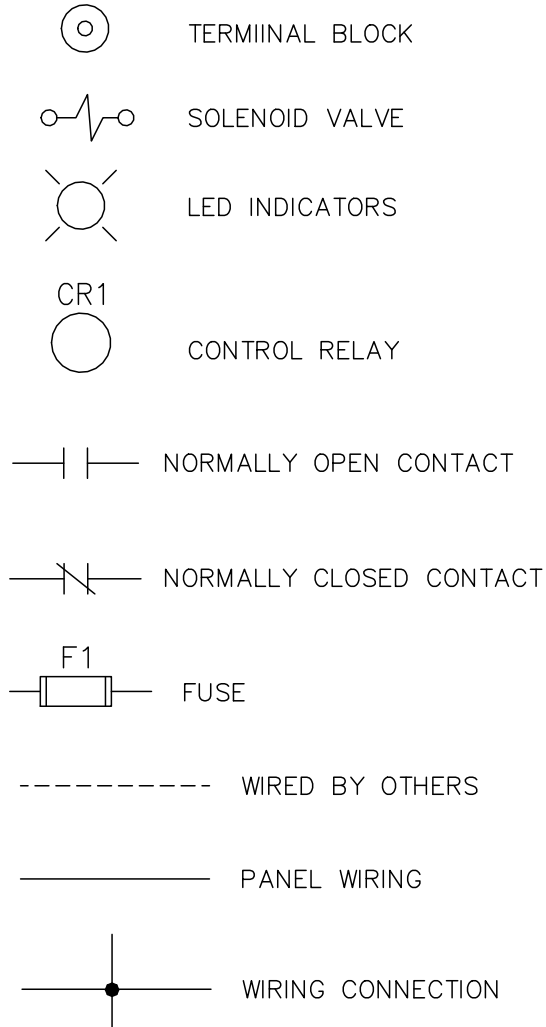

NOTES:

1. Panel wiring to be 18 AWG
Field wiring to be 14 GA THHN or larger
2. Wire numbers are the same as therminal numbers except where noted.
3. 5. Main circuit breaker to be 10 amp by others.

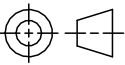
 ENGINEERING COMPANY <small>MANUFACTURERS of STEAM FIRED SPECIALTY EQUIPMENT</small>	Since 1986	CHK'D BY AS	TITLE ThermaFlo Engineering Co.			
			DRAWN BY MWB	SUBTITLE Pneu. & Temp. Pump Control Panel		
 DO NOT SCALE DRAWING	FILE NAME S03233-2.dwg	DATE ISSUED 04/13/10	SCALE N.T.S.	DRAWING NUMBER S03233-2	REV 0	SHEET 2
COPYRIGHT ©2004 SOLVERE LLC, BELMONT, NC, USA. ALL RIGHTS RESERVED. DESIGNS ARE OF A PROPRIETARY NATURE AND SHALL NOT BE REPRODUCED.						

WARNING: To reduce risk of fire, replace only with the below listed fuses or their Equivalents.
Fuse F1: MDL-7 - 7 amp

**120VAC 1 Phase 60hz
(Protected By 10 Amp Breaker)**

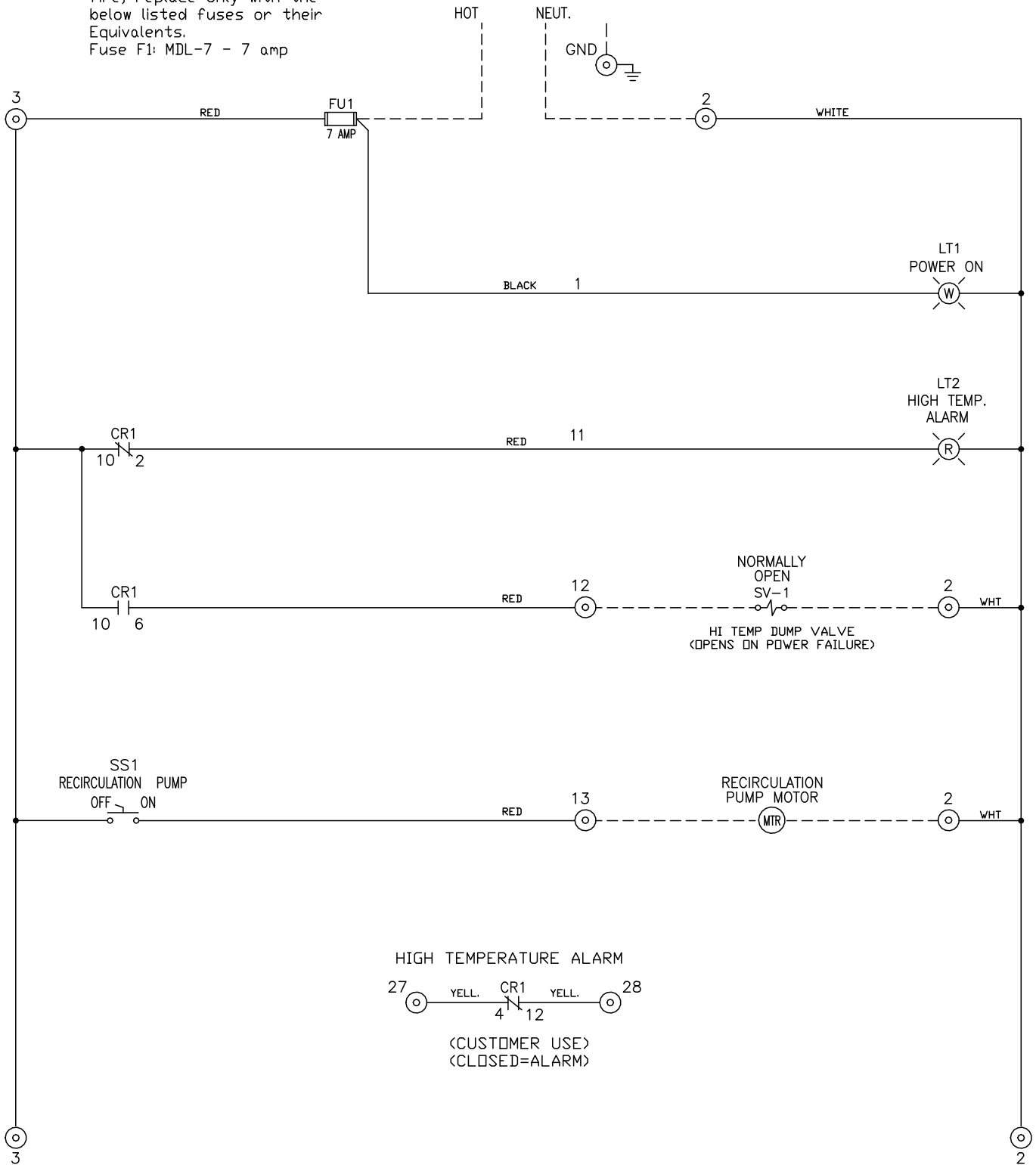

THERMAFLO
ENGINEERING COMPANY

Since 1986

MANUFACTURERS of STEAM FIRED SPECIALTY EQUIPMENT

CHK'D BY

AS

DRAWN BY

MWB

TITLE

**ThermaFlo
Engineering Co.**

SUBTITLE

**Pneu. & Temp.
Pump Control Panel**

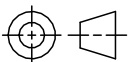

DO NOT
SCALE
DRAWING

FILE NAME S03233-3.dwg
DRAWING TYPE Electrical Schematics

DATE ISSUED
04/13/10

SCALE
N.T.S.

DRAWING NUMBER
S03233-3

REV
0

SHEET
3

WATLOW CONTROLLER PM6C1FJ-1RFAAAA PIN SCRIPTIIONS

SLOT A

OUTPUT 1 0-10 VDC 0-20MA	{	F1	VOLTS- / CURRENT-
		G1	VOLTS+
		H1	CURRENT+
OUTPUT 2 RELAY	{	L2	NORMALLY OPEN
		K2	COMMON
INPUT 1 ANALOG	{	T1	RTD+ / CURRENT +
		S1	RTD- / CURRENT- / VOLTS-
		R1	RTD+ / THERMOCOUPLE+ / VOLTS+

SLOT B

OUTPUT 3 0-10 VDC 0-20MA	{	F3	VOLTS- / CURRENT-
		G3	VOLTS+
		H3	CURRENT+
NONE	{	L4	
		K4	
INPUT 2 ANALOG	{	T2	RTD+ / CURRENT +
		S2	RTD- / CURRENT- / VOLTS-
		R2	RTD+ / THERMOCOUPLE+ / VOLTS+

SLOT C

120VAC POWER	{	98	POWER - 120VAC HOT
		99	POWER - 120VAC NEUTRAL
EIA 485 MODBUS RTU	{	CC	COMMON
		CA	T-/R-
		CB	T+/R+
		B5	
		D6	
		D5	

WATLOW CONTROLLER SLOT LOCATIONS

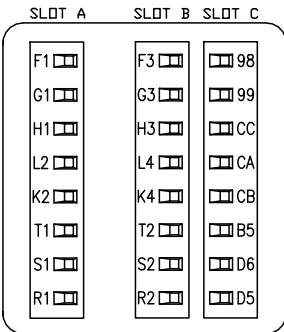

THERMAFLO

ENGINEERING COMPANY

Since 1986

MANUFACTURERS of STEAM FIRED SPECIALTY EQUIPMENT

CHK'D BY

AS

TITLE

**ThermaFlo
Engineering Co.**

DRAWN BY

MWB

SUBTITLE

**Pneu. & Temp.
Pump Control Panel**

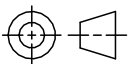

DO NOT
SCALE
DRAWING

FILE NAME	S03233-5.dwg
DRAWING TYPE	Electrical Schematics

DATE ISSUED	04/13/10
-------------	-----------------

SCALE	N.T.S.
-------	---------------

DRAWING NUMBER	S03233-5
----------------	-----------------

REV	0	SHEET	5
-----	----------	-------	---

CONTROL PANEL EXTERNAL CONNECTIONS

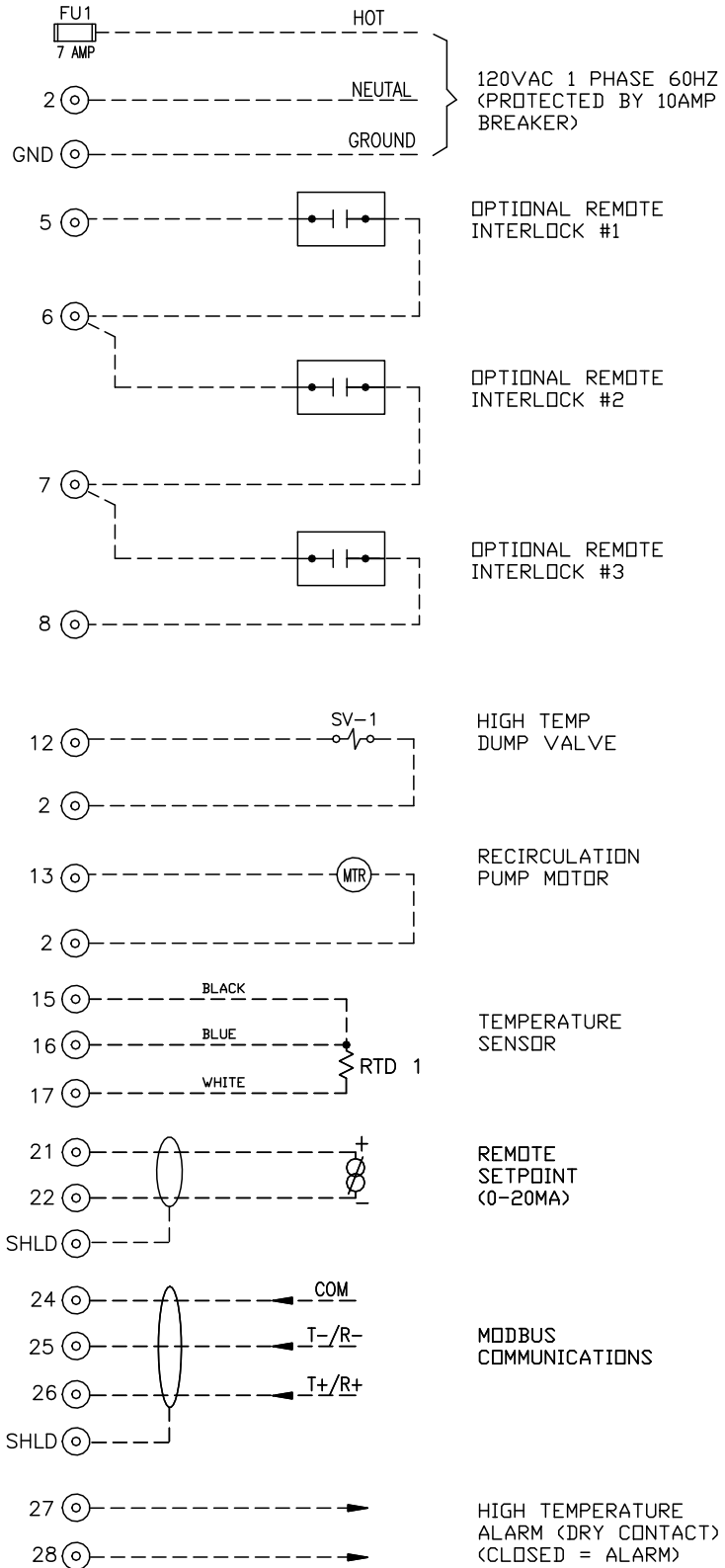

NOTE

⊙ CONTROL PANEL TERMINAL BLOCK SYMBOL

THERMAFLO
ENGINEERING COMPANY

Since 1986

MANUFACTURERS of STEAM FIRED SPECIALTY EQUIPMENT

CHK'D BY
AS

DRAWN BY
MWB

TITLE
ThermaFlo Engineering Co.

SUBTITLE
Pneu. & Temp. Pump Control Panel

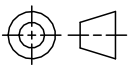

DO NOT SCALE DRAWING

FILE NAME S03233-6.dwg
DRAWING TYPE Electrical Schematics

DATE ISSUED
04/13/10

SCALE
N.T.S.

DRAWING NUMBER
S03233-6

REV
0

SHEET
6

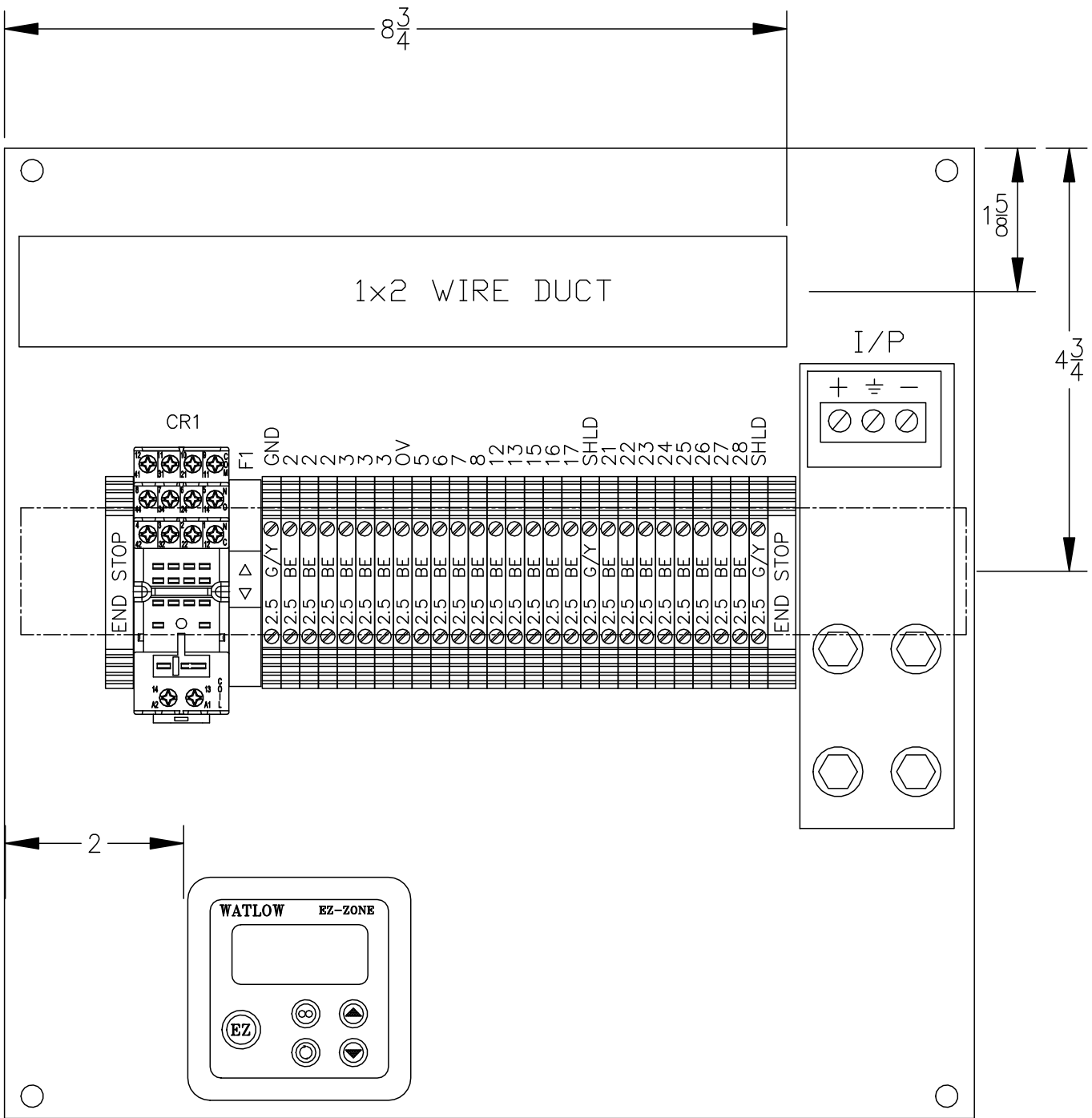

THERMAFLO
ENGINEERING COMPANY

Since 1986

MANUFACTURERS of STEAM FIRED SPECIALTY EQUIPMENT

CHK'D BY
AS

DRAWN BY
MWB

TITLE
ThermaFlo Engineering Co.

SUBTITLE
Pneu. & Temp. Pump Control Panel

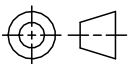

DO NOT SCALE DRAWING

FILE NAME S03233-7.dwg
DRAWING TYPE Electrical Schematics

DATE ISSUED
04/13/10

SCALE
N.T.S.

DRAWING NUMBER
S03233-7

REV
0

SHEET
7

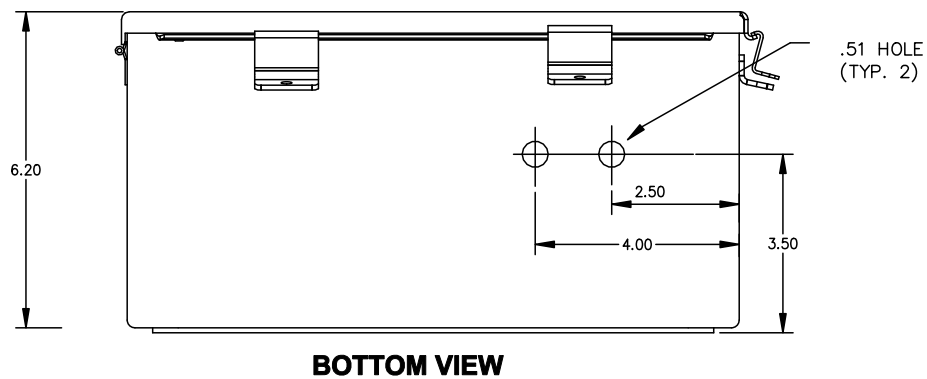
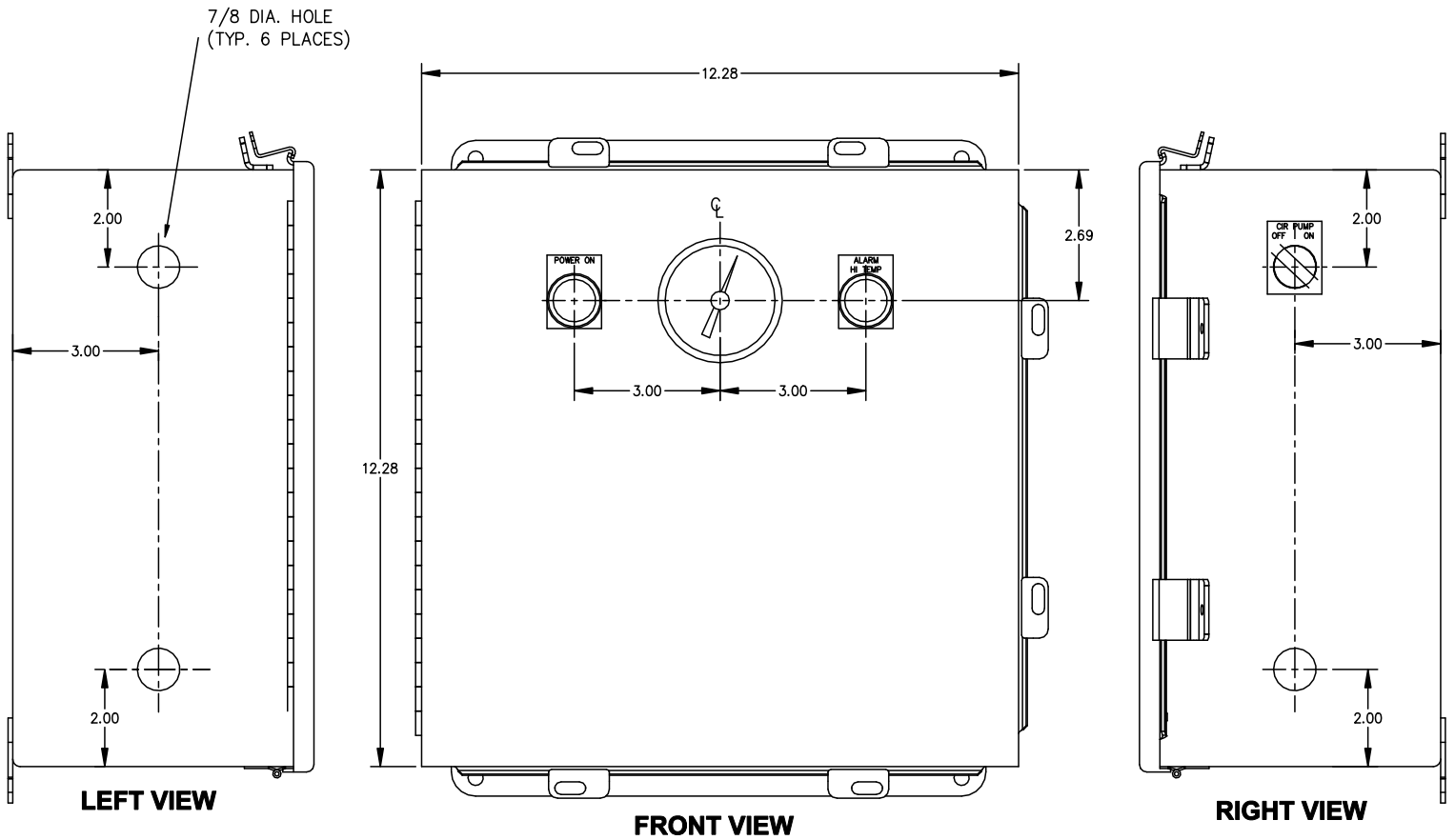

LEGEND PLATES

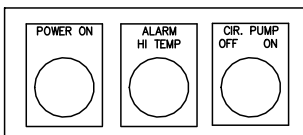

THERMAFLO
ENGINEERING COMPANY

Since 1986

MANUFACTURERS of STEAM FIRED SPECIALTY EQUIPMENT

CHK'D BY

AS

DRAWN BY

MWB

TITLE

**ThermaFlo
Engineering Co.**

SUBTITLE

**Pneu. & Temp.
Pump Control Panel**

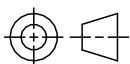

DO NOT
SCALE
DRAWING

FILE NAME S03233-8.dwg
DRAWING TYPE Electrical Schematics

DATE ISSUED
04/13/10

SCALE
N.T.S.

DRAWING NUMBER
S03233-8

REV
0

SHEET
8